

PVBAT

Tiger-T4

USER MANUAL
INSTALLATION GUIDE



PVBAT

POWER TODAY. SUSTAIN TOMORROW.

Table of Contents

1.	Introduction	3
2.	Features & Applications	3
3.	Product Specifications	4
	Unit Specification	4
	Product Detail	5
	System Diagram	9
4.	Screen Menu	10
5.	Mobile Application Guide	20
	Download & Install	20
	Registration & Sign in	21
	Add device & Connection	22
6.	Accessories	32
7.	Technical Safety Guidelines	33
8.	Transportation	34
9.	Recycling	35
10.	Warranty & Return Information	35
11.	Warnings & Precautions	37

1 Introduction

PVBAT's TIGER-T4 is an All-in-One (including battery, inverter and solar charge controller) energy backup system. This user manual is designed to provide an understanding of the specifications, features, capabilities, and installation of the 24-kilowatt-hour battery with a 16.5KVA inverter. It is important to read and note all safety information before installing or operating the TIGER. The document applies explicitly to the PVBAT TIGER-T4-72.



2 Features & Applications

PVBAT's TIGER-T4 is a 24KWh portable energy unit, ideal for solar systems, off-grid setups, and emergency power supply. It incorporates an advanced BMS (Battery Management System) for safe operation across a broad temperature range, ensuring quick and secure charging even at temperatures as low as 0°C. Designed for durability, it has an estimated lifespan of approximately 10 years. Its compact and elegant design is complemented by user-friendly monitoring through an app available on both iOS and Android devices, allowing users to track the TIGER's health and performance easily.

3 Product Specifications

3.1 Unit Specification

SKU #	PVBAT TIGER-T4-72
INVERTER POWER (KVA)	16.5
BATTERY CAPACITY (KWh)	24
MAX CHARGE VOLTAGE	86V
CELL CONFIGURATION	24S1P
DIMENSION	620×390×1135mm / 24.41 × 15.35 × 44.69 in
NET WEIGHT	269KG / 593.04 lb
PV IN CONNECTOR	BE175
PV INPUT VOLTAGE	90VDC-230VDC (Open Circuit Voltage)
PV INPUT MAX CURRENT	80 Amps (8KW)
PV CHARGING VOLTAGE:	83VDC~230VDC
DC PORT INPUT VOLTAGE RANGE (FOR BATTERY PARALLEL)	N/A
AC OUTPUT BREAKER CAPACITY	N/A
AC INPUT BREAKER CAPACITY	63 Amps
AC INPUT VOLTAGE RANGE	160VAC to 260VAC (UPS Mode) (2 Hot Wire , 1 Neutral Wire , 1 Ground)
AC INPUT CONNECTOR (ON THE SIDE)	NEMA SS2-50P (120VAC/240VAC , 50Amp)
AC OUTPUT RECEPTACLE (ON THE SIDE)	NEMA 14-50R (120VAC/240VAC , 50Amp)
AC OUTPUT RECEPTACLE (ON FRONT PANEL)	4x 120V Receptacle , 1x L14-30R (120VAC/240VAC , 30Amp)
USB PORT	N/A
COMMUNICATION PORT	2x Rs485, 1x Generator Kick Off Port , Wi-Fi

3.2 Product Detail

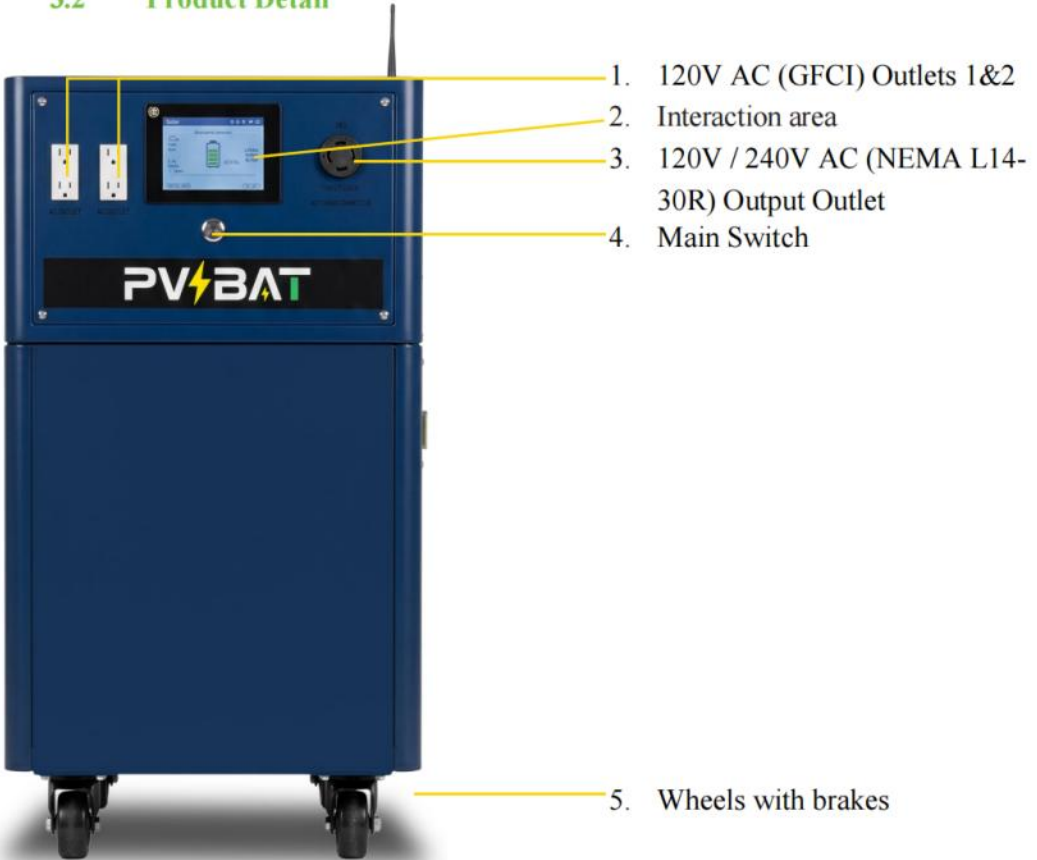

Descriptions:

1. Standard GFCI class A Outlet providing 120V power.
2. The area for getting TIGER information and performing settings. For detailed information, please refer to Section 4;
3. It's a Twist Lock Outlet (NEMA L14-30) provides 120V / 240V power.
4. This is the main switch. When it is turned off, it cuts off all power supply. However, TIGER can still provide AC power if the AC input is connected while the main switch is off. In this status, known as the bypass status, the battery of TIGER cannot be charged or discharged.
5. These are 360-degree rotating wheels, and the wheels equipped with manual brakes.

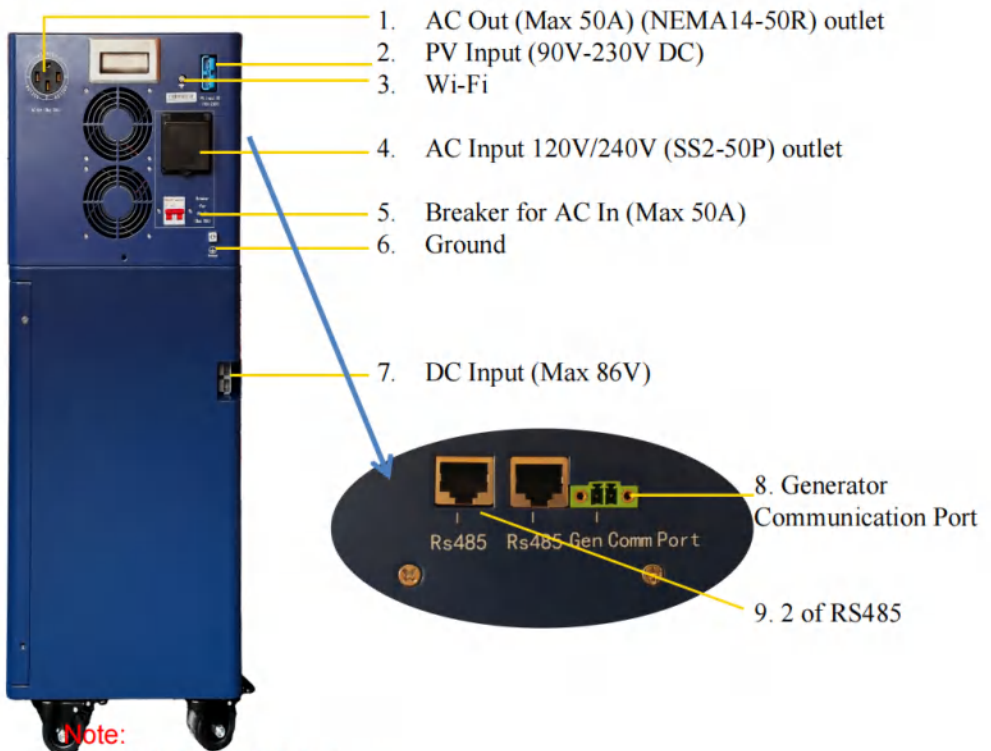

Note:
 The battery pack has a separate switch and reset button.

Descriptions:

1. This 50A Embedded Ground Blade Power Outlet (NEMA14-50R) provides 120 or 240V AC power.
2. The Wi-Fi antenna is used to enhance the signal and the stability of the connection.
3. It is a blue BE175 connector used to connect to solar charging systems.
4. It is a Twist Lock Outlet (SS2-50P) used to charge the TIGER from the grid.
5. AC safety circuit breaker. It is a safety control of the AC input; TIGER is completely disconnected from the grid before turning on the breaker, preventing AC charging and bypassing functionality.
6. It is a ground wire screw hole.
7. It is an BE175 connector that connects an external DC charger or the TIGER expansion battery packs.
8. In the absence of grid power, when the TIGER voltage drops to 72V, the dry contact will close after 10 seconds, triggering the external electric generator to start. After 1 minute, the dry contact will automatically disconnect.
9. It is a communication port for interacting with the TIGER's BMS (Battery Management System).

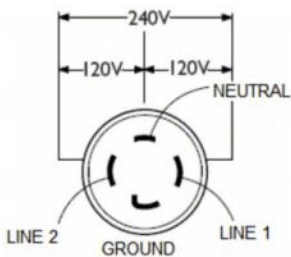

NEMA L14-30

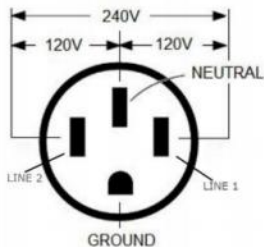

NEMA14-50R

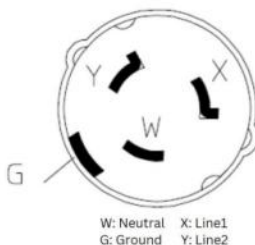

SS2-50P

The ground wire should always remain connected to prevent short circuits and avoid potential damage.

NEMA L14-30 & NEMA14-50R: Line1 + Neutral = 120VAC
 Line2 + Neutral = 120VAC
 Line1 + Line2 = 240VAC

SS2-50P:
 X + W = 120VAC
 Y + W = 120VAC
 X + Y = 240VAC

What is inside the Inverter box:

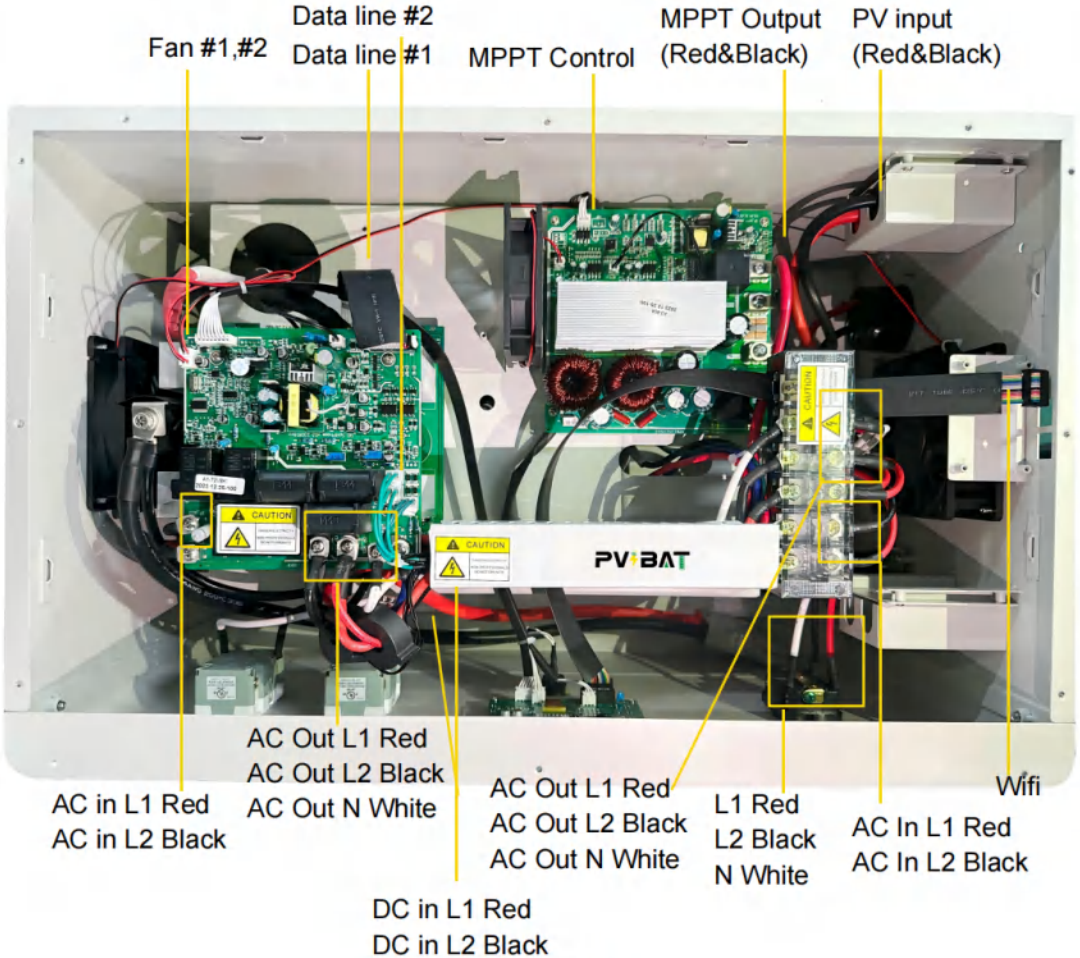

The Fire Extinguisher is included:



3.3 System Diagram

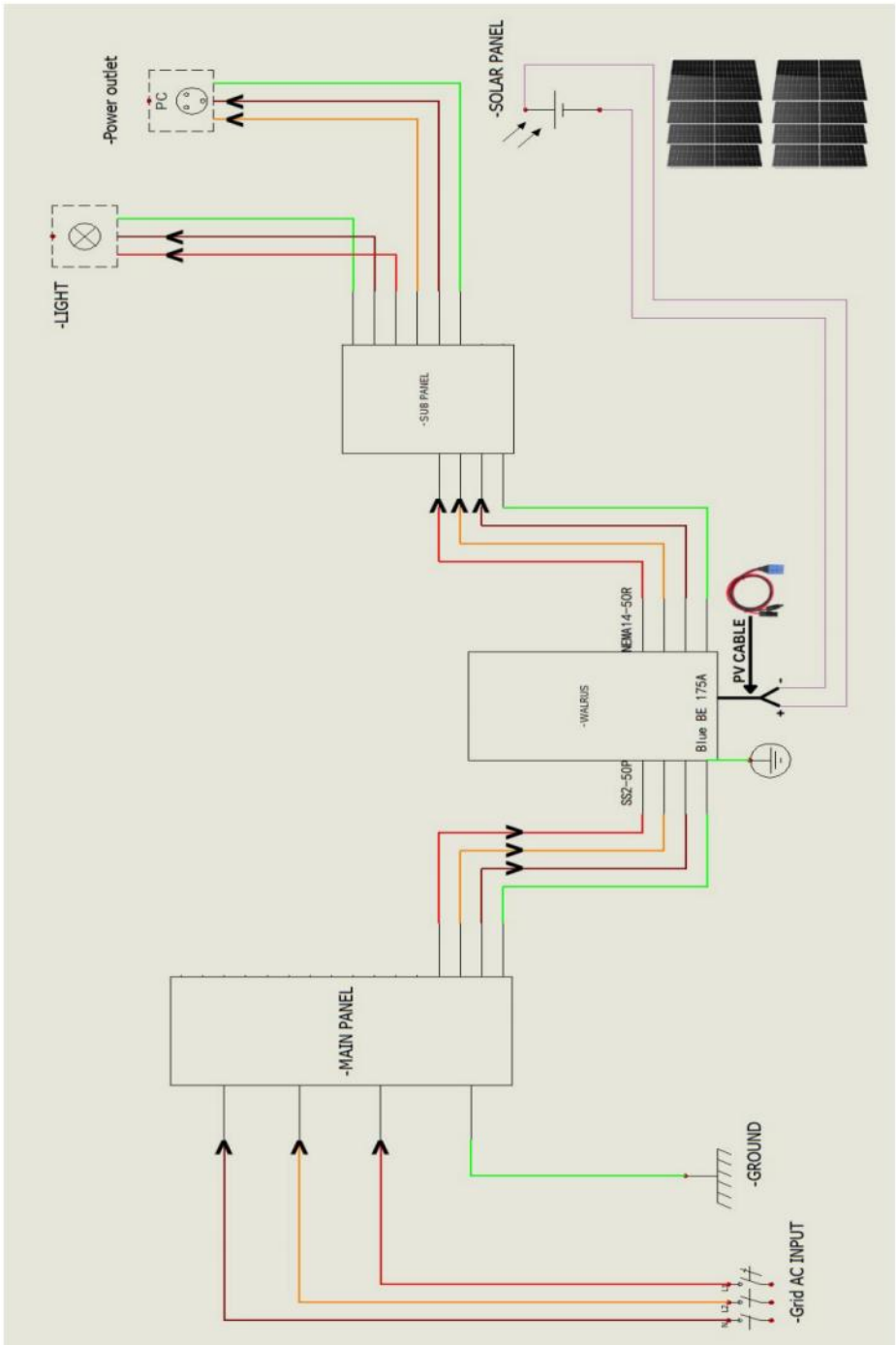

4 Screen Menu

The most system interactions of PVBAT's TIGER can be operated via the front 7-inch smart touchscreen. Users can configure various working parameters on this screen, such as charging power and operational mode, for the TIGER. Additionally, it provides real-time information on the TIGER's operational status, including the inverter's output power and load percentage, parameters, and the working status of each feature.



Note: When the total power of the connected appliances exceeds 16.5KVA, a red light will flash, and an alarm will sound for 30 seconds, after which the system will shut down. Upon hearing the alarm, it is recommended that the total power of the appliances need to be reduced. The system will automatically restart within 3-5 seconds. If the total power of the appliances continuously exceeds 16.5KVA three times, the inverter will shut down completely to protect the system.

Main Page

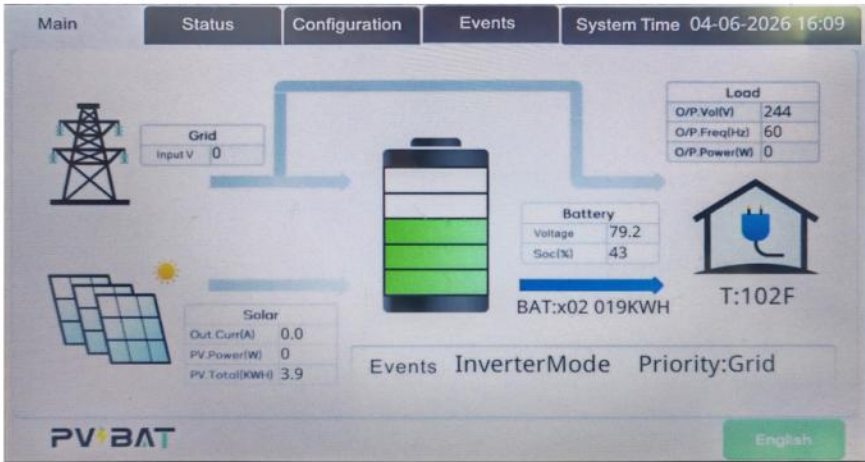

The main interface of the TIGER displays the real-time operational status of the system, including interactions between the grid, solar power, load, and battery.

Key data on the main interface includes:

- **Grid Information:** Shows real-time input voltage data.
- **Solar Information:** Displays the operating status of the photovoltaic system, including output current, output power, and total PV input power.
- **Battery Information:** Includes battery voltage and state of charge (SoC), helping users monitor the current battery charge level.
- **Load Information:** Shows real-time load voltage, frequency, and output power.
- **Temperature Information (T):** Displays the internal system temperature in Fahrenheit, ensuring the device operates within a safe temperature range.

At the bottom of the screen, there are options for different operating modes (e.g., Inverter Mode, Priority Mode) and access to event logs, allowing users to monitor and configure the system's operating mode.

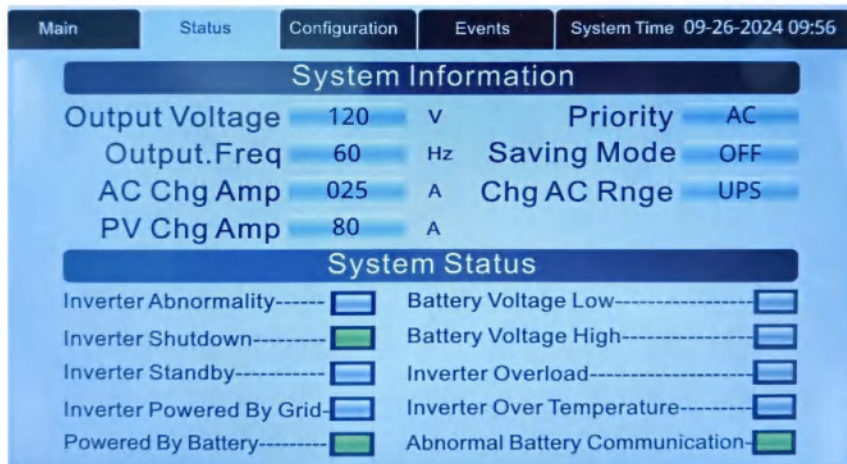

The status page of the TIGER provides detailed operational information and displays the current system status. The page is divided into two sections:

1. System Information:

1. **Output Voltage:** Displays the set output voltage;
2. **Output Frequency:** Shows the set output frequency(in Hz);
3. **AC Charge Amp:** Displays the maximum AC charging current;
4. **PV Charge Amp:** Shows the maximum solar charging current;
5. **Priority:** Displays the system's current priority mode;
6. **Saving Mode:** Shows the status of the saving mode;
7. **AC Charge Range:** Displays the current mode of the grid power.

2. System Status:

1. This section uses indicator lights to show the system's operational status:
 1. **Green light on:** Indicates the current state.
 2. **Red light on:** Indicates a warning state in the system.
 3. **No light on:** Indicates the system is not in this state.
2. The statuses include: inverter abnormality, inverter shutdown, inverter standby, inverter powered by grid, powered by battery, battery voltage low, battery voltage high, inverter overload, inverter over temperature, and abnormal battery communication.

Configuration Page



Password is required every time you enter the configuration page.
(default password is: **101**)

Configuration Page Explanation

The configuration page of the TIGER allows users to adjust several key parameters based on system requirements. The available settings on this page include:

- 1.Output Voltage:** Users can set the system's output voltage;
- 2.Output Frequency:** Set the system's output frequency (in Hz);
- 3.AC Charge Amps:** Adjust the maximum charging current from the AC power source;
- 4.PV Charge Amps:** Set the maximum charging current for the solar system;
- 5.Chg AC Range:** Select the AC charging range, depending on different application scenarios;
- 6.Priority:** Set the system's priority mode, such as AC or solar priority.
- 7.Saving Mode:** Turn the saving mode on or off to improve energy efficiency.
- 8.Set Battery:** Configure battery-related parameters to ensure proper integration with the system. (Separate password required)
- 9.Save Time:** Allows users to set the system time and date to ensure synchronized operations.

This page enables users to fine-tune the system according to different operating environments and needs, ensuring the TIGER runs optimally.

Output Voltage setting

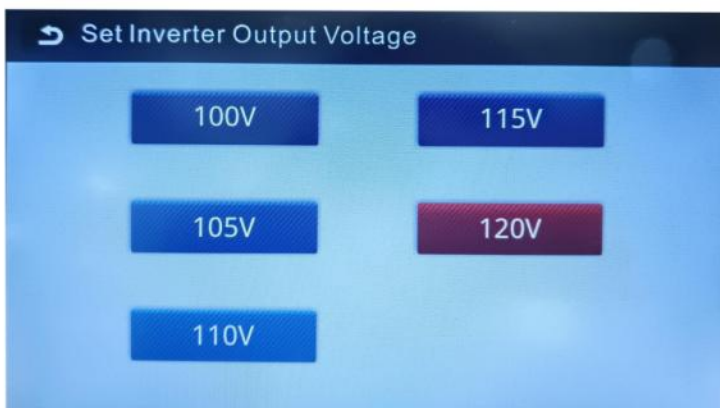

Editing the output voltage of the standard GFCI class A outlets, while the output voltage of the Twist Lock Outlet (NEMA L14-30) will be two times (= 2 X selected voltage).

Output Freq-(Hz) setting

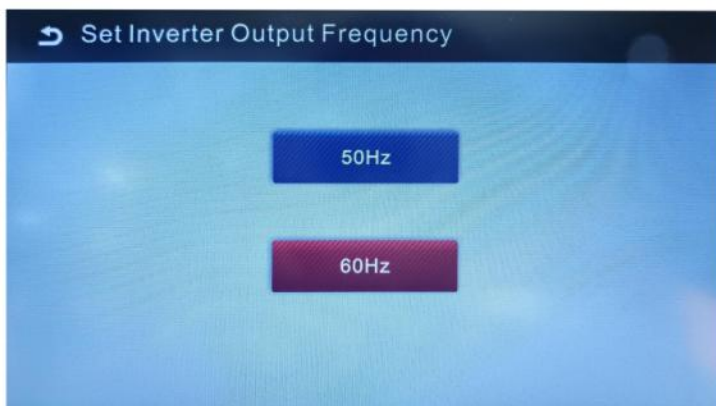

Editing the output AC frequency for both Standard GFCI class A Outlet, Twist Lock Outlet (NEMA L14-30), and Embedded Ground Blade Power Outlet (NEMA14-50R).

AC Chg Amps(A) setting

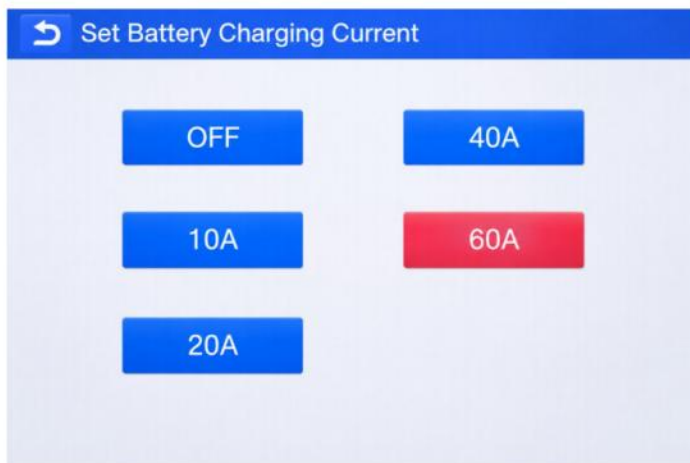

Select the AC charging current from the options provided.

PV Chg Amps(A) setting



Select the PV charging current from the options provided.

Chg. AC Range setting



The AC input voltage range varies with the power mode—UPS or INV. In Uninterruptible Power Supply mode, the device uses external AC as the main power and switches to the battery if AC fails, maintaining power without interruption. Inverter mode mainly uses the battery, converting DC to AC, and can keep powering loads even without external AC, provided the battery has enough charge.

Priority setting

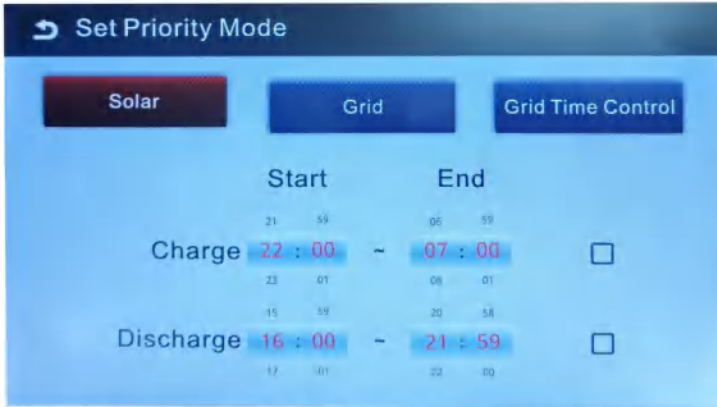

Select one of the provided charging modes; When the solar charging mode is selected, grid charging will be disconnected. However, when the grid charging mode is chosen, both solar and grid charging will occur simultaneously. For 'Grid Time Control', requires input time information. **Attention:** Before setting the AC/Grid Time Control (ATC), please ensure that TIGER's local time is set correctly.

In the 'charging time management' setting, "Charge" refers to TIGER being charged within the set time frame. During this period, only the bypass power supply mode is available when connected to the grid; the inverter power is charging the battery only.

Conversely, during the set discharge time period, TIGER will not charge and will operate in an inverter-priority power supply status.

Let us take the data from the image above as an example. It shows from 10 PM to 7 AM the following day, TIGER will be in charging mode. During this time, the TIGER's battery will choose the charging mode based on the available options and selected priorities, and the electricity the machine provides comes from the grid. Conversely, TIGER will be discharging from 4 PM to 9:59 PM. This means that during this period, TIGER will not charge the battery anymore. it will release the electrical energy it has stored or bypass the grid energy to the application/payload .

Note: Do not overlap the time setting for charge and discharge. If there is an overlap, the TIGER will only operate in charging mode during this period until the set charging time ends.

The time here can be set manually. To change it, move the cursor to the desired data field and select it, then adjust the time using the up and down buttons. Once the time is set, move the cursor to the box on the right side and click; a displayed '■' indicates this charging time setting is activated.

ACT is actually the most cost-effective solution. During charging, if the PV remains connected, TIGER will not block it. Once the battery is fully charged, TIGER will not continue to charge and will only operate in bypass mode.

SAV MODE setting

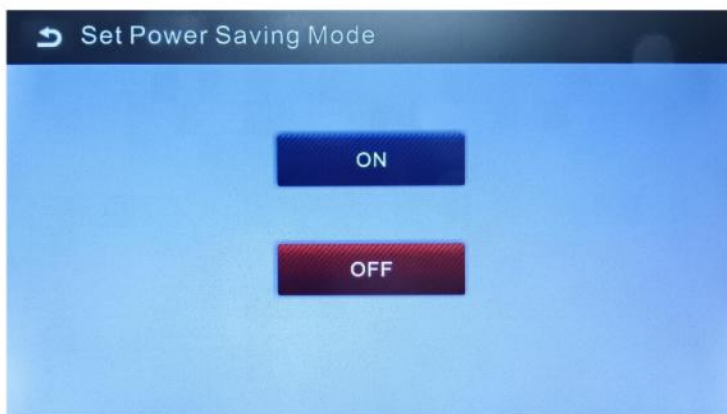

Select whether to activate the power saving mode, which will limit the power consumption of TIGER in standby mode.

Set Battery setting

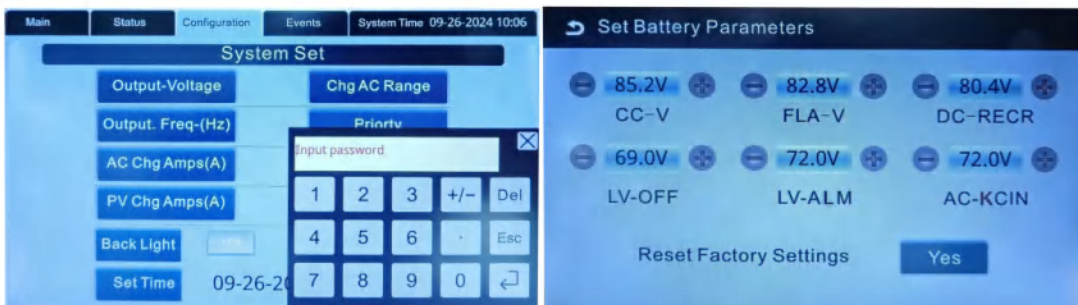

- CC-V: Constant Current/Constant Voltage. The 85.2V represents the battery charging voltage;
- FLA-V: Float Voltage. It is the voltage (82.8V) at which a battery is maintained after being fully charged to maintain that capacity by compensating for battery self-discharge;
- DC-RECR: DC Recover. The voltage must exceed 80.4V in order for the inverter to restore;
- LV-OFF: Low Voltage Cut-OFF. When the battery voltage falls below 69.0V, the power supply from the battery will be cut off;
- LV-ALM: Low Voltage Alarm. Over-low Voltage Warning value, the battery will alarm when the voltage lower than 72.0V;
- AC-KCIN: Grid Kick in. When the battery voltage is lower than 72.0V, the grid will prioritize charging the battery only when the grid is connected. Once the voltage reaches the 72.0V, DC charging will become available. This may occur when setting the priority to solar, and the solar charging is no longer available.

(default password is: 505)

Warning: Please don't change any parameter, It might lead to a very danger situation.

5 Mobile Application Guide

Downloading the App

- Scan below QR code to download and then install it.



Installing the App

- Once the download is complete, the app will automatically begin the installation process.
- After installation, you'll find the SmartESS app icon on your home screen or app drawer.



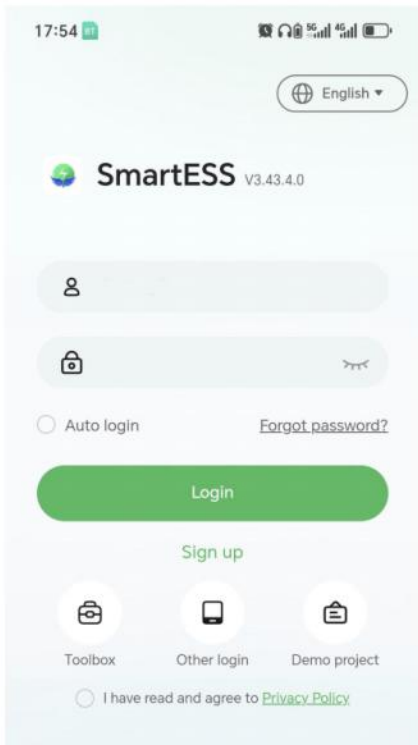

Logging In to the App

- Open the PVBAT app.
- Enter your registered username/email/phone and password, then click the checkbox and tap "Sign in" to access your account.

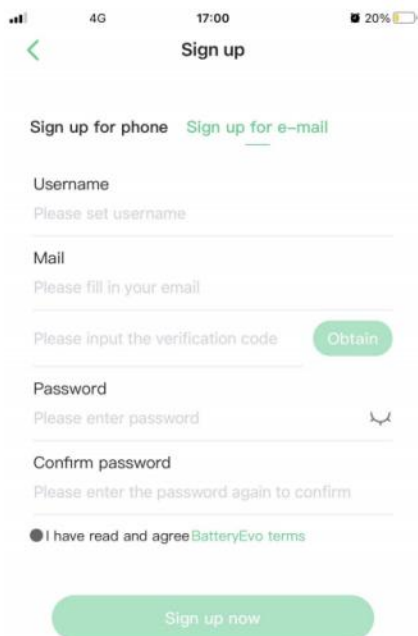

Registering an Account

- On the log-in page, select "Sign Up" to register a new Account.
- Fill in the required fields with your details, such as username, email address, and password.
- Read and accept the Terms of Service and Privacy Policy, then submit your registration.
- You may be asked to verify your email address. Check your email inbox for a verification code from PVBAT and click on it to confirm your account.



Add a device (datalogger)

- After logged in, there will be the list of added devices or datalogger.
- To add a new datalogger, you need to click the “+” button.



- Find the PN number and bar code at the top of the Wi-Fi antenna.
- Enter the provided PN number to the input text bar at the bottom, or use the scan option to scan the bar code to get the PN number.
- After the PN number is entered, you can go to the next step.

16:30 17%

Add a datalogger Done

PN* E50000220248230672

Design power(kW)* 13

Datalogger name carol

Installer No installer

Installation date 2024-01-09

Time zone GMT -6

Country Please enter country

Datalogger address* Linxia

Currency RMB(¥)

Generation income 1.2

Buying electricity price 1.2

Selling price 1.2

- Complete the parameter as far as possible
- There are two required fields: “Design power(KW)” ---13 “Datalogger address”--- Your location, you can click the icon to enter to the GPS to get the location.

17:12 3%

Device

Datalogger Search

All Pn A-Z

Carol
PN:E50000220248230672

0 0 0

Monitor Alert Me

- At the top left of the page, find the drop-down list of presentation types.
- Click on the drop-down list and select "Datalogger". Added devices will displayed in the list.

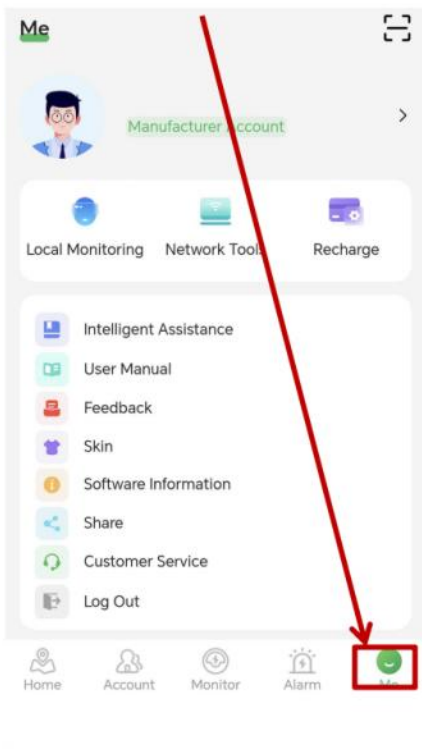

Wi-Fi Pairing

- To pair TIGER to the local Wi-Fi, we need to ensure the local Wi-Fi is working properly.
- Click the “Me” option on the navigation menu at the button.

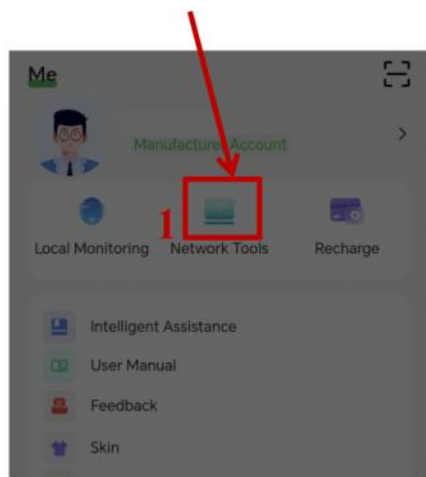

Please select the tool
You can use different ways to connect your devices

- Click the “Network tools” icon the option box will pop up here.
- Select “Wi-Fi network” to go to the Wi-Fi pairing setting page.

BLE network
2 Wi-Fi network

Cancel

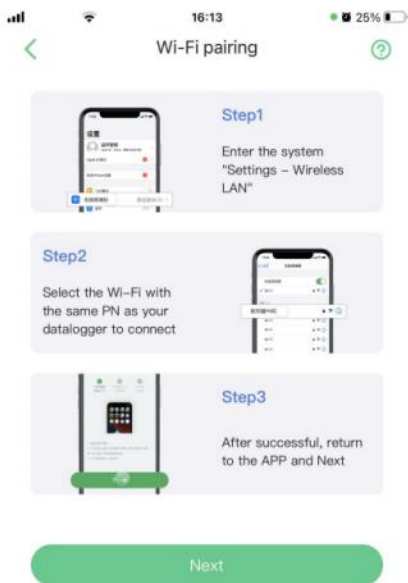

- Before the next step, the mobile device should connect to the datalogger as the Wi-Fi connection.

- Select the datalogger network that is the same as the PN number on TIGER.
- The password for the datalogger: 12345678





- Click the “Next” button to access the next page.
- If a prompt window pops up, the datalogger connection has failed and needs to try again.

- Enter or select (by clicking the Wi-Fi icon) the local router to which the datalogger should be connected.
- Enter the router’s password.

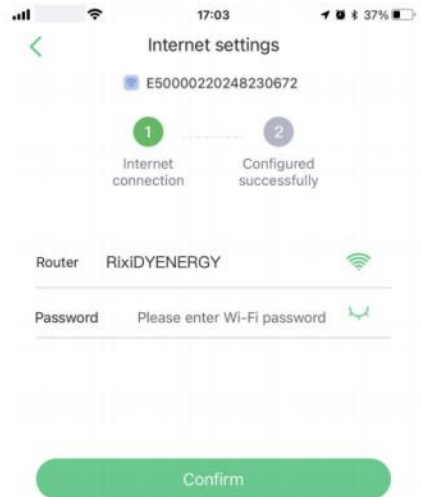

Reminder

1. Please ensure that the signal connecting to the network is good and the network is unblocked. n2. Currently, routers in the 5G band are not supported. Please use routers in the 2.4G band n3. Ensure that the password of the router is correct

Setup failed? [Network diagnostics](#)



- Once the network is paired, the mobile device can directly read TIGER's real-time status in the software by connecting to the local network.
- If the system reports an error or the connection fails, then it is recommended that the pair be done again or try another connection solution. Alternatively, contact PVBAT technical support team for assistance.

Bluetooth Pairing

- Click the “Network tools” icon the option box will pop up here.
- Select “BLE network” to go to the Bluetooth pairing setting page.

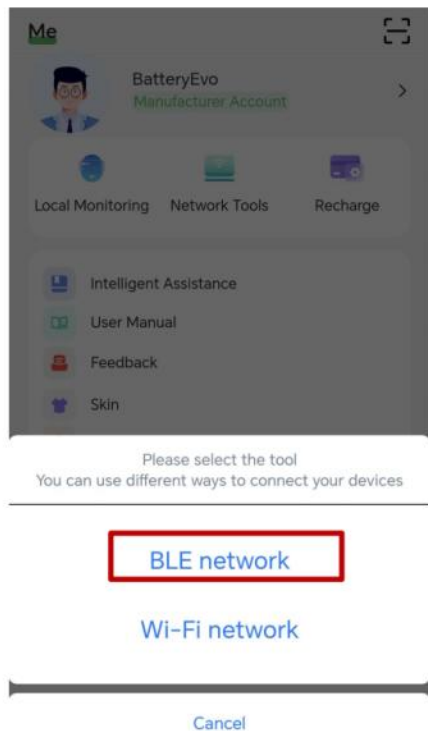



- Bluetooth either activates automatically or requires manual enabling.
- The App then initiates a search for nearby devices with Bluetooth capabilities.

- Select the Bluetooth which has same PN number with datalogger from the listed device.

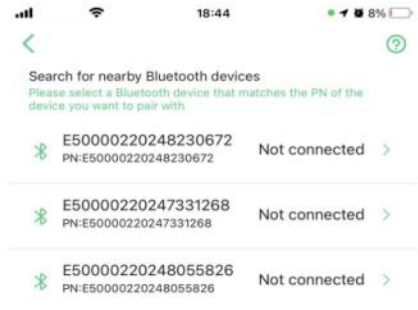

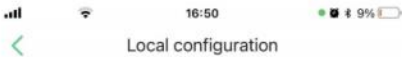

You have connected the datalogger:
E50000220248230672

Internet settings

- Bluetooth connected successful to the datalogger.
- Click “Internet Settings” to continue the datalogger pairing to the local router.



- Enter or select (by clicking the Wi-Fi icon) the local router to which the datalogger should connected.
- Enter the router’s password.

Set up

Setup failed? Network diagnostics



- Once the network is paired, the mobile device can directly read TIGER's real-time status in the software.
- If the system reports an error or the connection fails, then it is recommended that the pair be done again or try another connection solution. Alternatively, contact PVBAT technical support team for assistance.

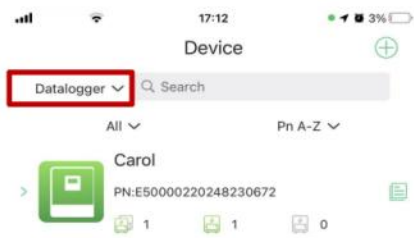

Viewing PVBAT TIGER T4 Status

- At the top left of the page, find the drop-down list of presentation types.
- Click on the drop-down list and select "Datalogger". Added dataloggers will displayed in the list.

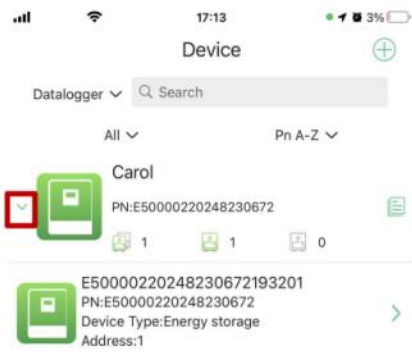



- Click triangle icon on the left of the datalogger. Devices that are already connected to datalogger will be shown below.
- Click the device.



- The system status and data are synchronized in real-time.



6 Accessories

Name	Description	Status	Image
PV to BE 175 Cable	This cable is used for connections from the PV connector to the blue BE connector.	In box	
72V Battery Charger	A 72V battery charger can charge the battery via a DC input. Charging Voltage is 74.7V.	Optional	
Twist Lock Socket (SS2-50P)	120 Volt / 240 Volt Power Cord Twist Lock Socket, which can be installed on the power grid to serve as a connection point for the battery to supply power to the grid.	Optional	
Embedded Ground Blade power Socket (NEMA14-50R)	This socket can be installed on the power grid to serve as a connection point for providing power to the battery from the grid.	Optional	
50 Amp 10 Ft RV Extension Cable	This cable is suitable for connecting the battery output to the power grid.	Optional	

Optional items are available on the website.

7 Technical Safety Guidelines

⚠ WARNING: Before installing or operating TIGER, please make sure to review all safety guidelines, warnings, and precautions thoroughly.

Do not install TIGER in a location that is exposed to direct sunlight and water. Do not charge TIGER with a voltage exceeding 75.6V. Do not charge the TIGER when the temperature is below 0°C. Do not discharge TIGER when the temperature is below 0°C. Do not charge or discharge TIGER when the temperature is above 65°C. Do not charge TIGER to 65.1V or higher if you intend to store the TIGER for more than 6 months.

Additionally, when installing the TIGER, cooling is a very important consideration. To ensure the efficient and safe operation of the device, it is recommended to install it in a place with good air circulation. The TIGER has two fans, one on the left side (without a connection port) that serves as the air intake, and another on the right side (with a connection port) that serves as the air outlet. Good airflow helps to dissipate the heat generated by the device's operation, thus preventing overheating and extending the life of the device. Avoid installing the device in enclosed or narrow spaces, as the air circulation in these places is poor and not conducive to the timely discharge of heat. Regularly checking and maintaining the air circulation paths around the device is also key to maintaining effective cooling, ensuring that there are no obstacles hindering air flow.



8 Transportation

⚠ WARNING: Before installing, make sure to review all safety guidelines, warnings, and precautions thoroughly.

1. TIGER should be kept upright, and the brakes on the wheels should be engaged to secure PVBAT TIGER T4.

DOWN, Brakes
ON



UP, Brakes OFF



2. TIGER T4 gross weight 245KG / 540LBS. Special equipment is required to load it in the truck (e.g. forklift)



9 Recycling

Dispose of LiFePO₄ batteries at an authorized lithium recycling facility. Our authorized recycler is below.

10 Warranty & Return Information

In the unlikely event you are having an issue with one of our batteries we have developed a straightforward warranty & return policy:

- 30-day money back guarantee. Full refunds may be issued for returns of undamaged batteries not related to warranty claims, subject to a 20% restocking fee.
- We have a comprehensive 10-year warranty on all new batteries.

- » We take pride in the durability of our batteries, confidently endorsing both our engineering prowess and the high standards of our quality. If we made a mistake or there is a defect in the build of your TIGER, we will fix it or fully replace it.
 - » PVBAT offers a 10-year manufacturers defect warranty from the date of purchase. The average lifespan of a PVBAT battery at 100% Depth of Discharge is between 6,000 – 10,000 recharge cycles depending on chemistry, or roughly 5 to 10 years with standard use (see the specifications of TIGER for more information). This warranty does not cover negligence or misuse of TIGER or the normal wear and tear. If it is deemed that TIGER was used improperly, you will be subject to a \$150 an hour repair charge plus parts and shipping.
 - » To submit a warranty claim, please contact us. The owner may be required to ship TIGER back to our warehouse for further inspection.
- We offer a 30-day warranty on all accessories & complimentary products (BE connectors, wiring, etc.).
 - Free lifetime technical support & troubleshooting.
 - Warranty is non transferable and only applies to its original owner.
 - Warranties can be used once per internal component for an exchange/replacement.
 - Customer pays return shipping on all returns or warranted component inspections initiated after the first 30 days of ownership. Please note some TIGER returns may require special documentation and packaging, and these instances will incur extra fees. This is to correctly comply with lithium battery shipping regulations.
 - If you have a quality issue with a product, please contact our support team to help properly diagnose the problem. If the product you received does not meet our rigorous quality standards, then we will issue you a replacement component or fix the original at no additional cost. Replacement batteries or components will only be sent after we have received and inspected your returned TIGER or component to determine the cause of any problems. PVBAT is not responsible for return shipping.
 - DIY modifications or damage due to gross negligence or abuse are not covered by the warranty.

11 Warnings & Precautions

Lithium batteries are a safe chemistry, but it is important to follow safety measures when handling any electronics. Please adhere to this manual's instructions for safe handling and operation.

General Safety

- Always wear protective gear when handling batteries.
- Use a wrench with a rubber-coated handle.
- Do not place TIGER on conductive materials or above a damp ground.
- Keep any flammable/combustible material (e.g., paper, cloth, plastic, etc.) at least two feet away from the batteries.
- Keep sparks, flames, and metal objects away from batteries.
- Have a Class ABC fire extinguisher on the premises.
- Do not inhale gases emitted from TIGER.
- Do not dispose of in the environment. Dispose of in a chemical products recycling bin.
- Never dispose of cells in a fire or expose to high temperatures.
- Do not subject batteries to strong mechanical shocks or fling.
- Never disassemble, modify, or deform batteries.
- Do not connect the positive terminal to the negative terminal with electrically conductive material.
- Do not use TIGER in the rain.
- Do not use TIGER under direct sunshine.

Installation Precautions

- Check that all cables are in good condition.
- Make sure all cable connections are properly tightened.
- Install and remove batteries using the handles provided. It is best to use the handle to move TIGER.
- Do not install batteries in a zero-clearance compartment to prevent overheating. Ensure at least 4 inches of clearance on all sides and the top of TIGER for necessary heat dissipation.
- TIGER compartment and any material within two feet should be noncombustible.

Charging and Handling

- In the case of charging, use only a dedicated battery charger. Battery Charging Voltage must be under 80VDC.
- Charge according to the conditions specified by the user manual.

Hazardous Emergency Treatment

- If TIGER exhibits any abnormal conditions, such as overheating or smoking, immediately disconnect all connections. Do not perform any operations until it is confirmed safe.
- If there is a short circuit in TIGER or the connected power grid, immediately disconnect all connections. Do not perform any operations until it is confirmed safe.
- In the event TIGER continuously smokes or even catches fire, promptly use a fire extinguisher and douse with copious amounts of water to suppress the chemical reaction.
- If TIGER is damaged but the situation is under control, ensure to move TIGER to a safe and open area for 2-3 days to prevent any potential hazards.
- During a fire, batteries can release large amounts of corrosive gases. Stay away from the area or wear breathing apparatus for protection.



THANK YOU

Thank you for choosing PVBAT.

PV  **BAT** 

— POWER TODAY. SUSTAIN TOMORROW. —

 PVBAT.COM